



DA

DA.23.07.12

1	3
2	4
3	5
4	6
5	7
5.1	7
5.2	8
5.3	9
6	10
6.1	10
6.2	10
7	11
7.1	11
7.2	13
7.2.1	(AUT-CAL).....	13
7.2.2	(I-CAL).....	14
7.2.3	(E-CAL).....	14
7.2.4	(TEC-CAL).....	15
7.3	16
8	17
8.1	18
8.2	().....	19
9	21
10	23
11	24
12	25
13	26
14	27
15	28
16	29
17	30
18	31
19	32
20	34
20.1	35
20.2	36

	20.3	37
21		38
	21.1	38
	21.2	40
22		42
23		43
	23.1	43
	23.2	44
24		46
25		47
26		49
	26.1	50
	26.2	50
	26.3	50
27	RS232	51
28		57
29		58
30		59
31		60
32		61
33		63

1



•

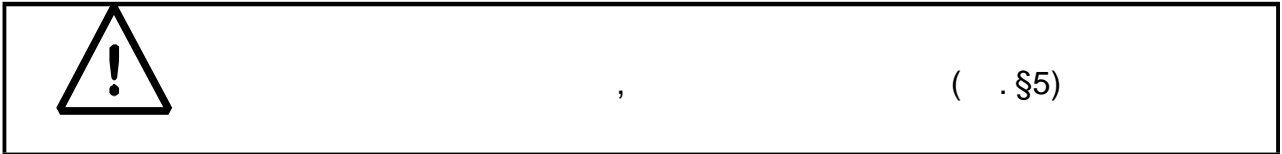

•

•

•

80%

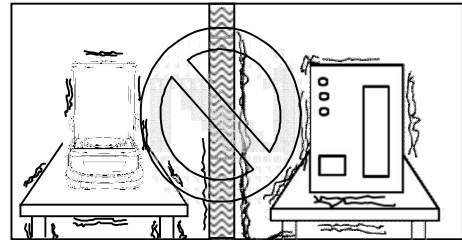
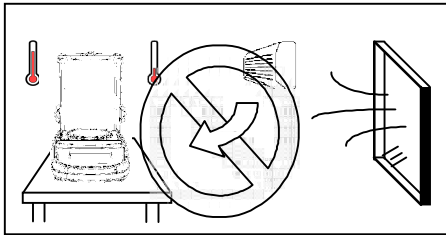

•

(. §3).

•

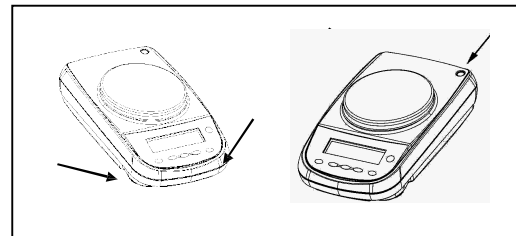
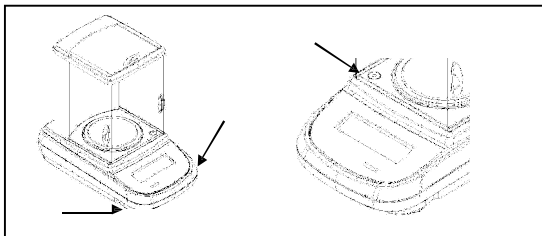

•

(. §5).

•

•

- 0,01). 8 (0,1
- 30 (S7).

[ON/OFF]

•

•

•

•

2

•

: +5 °C ÷ +40°C

•

80%.

•

•

•

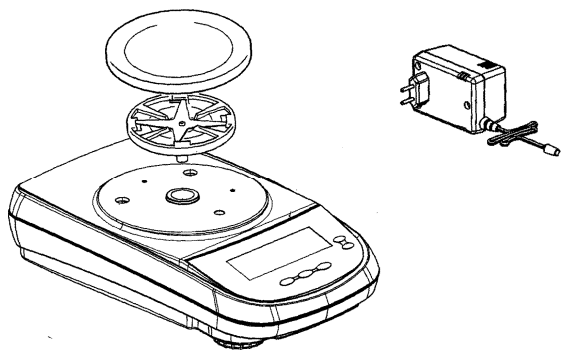
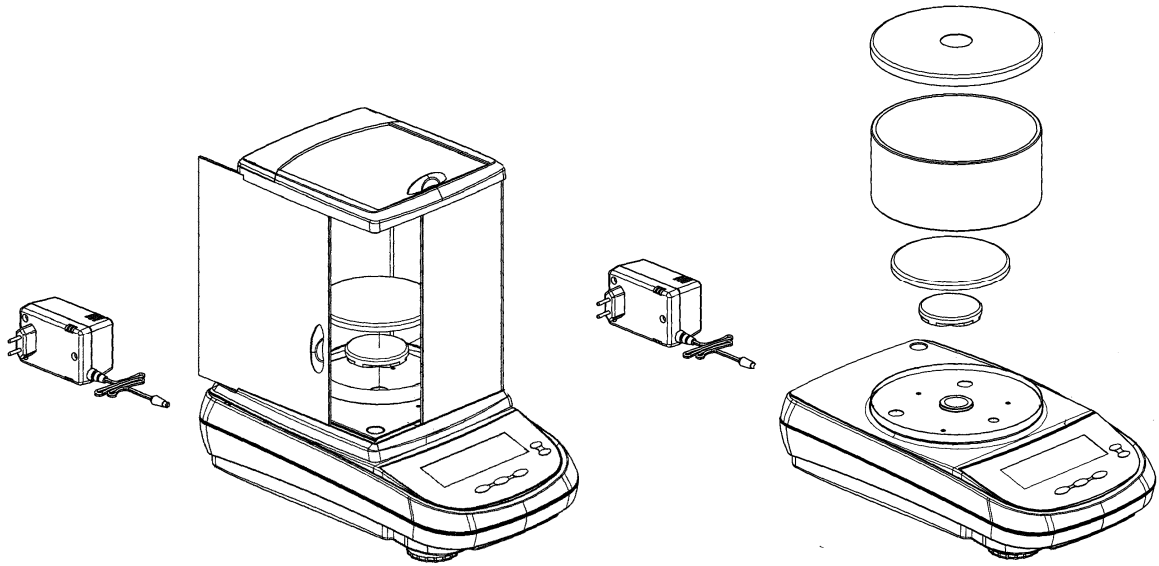

:

0,01



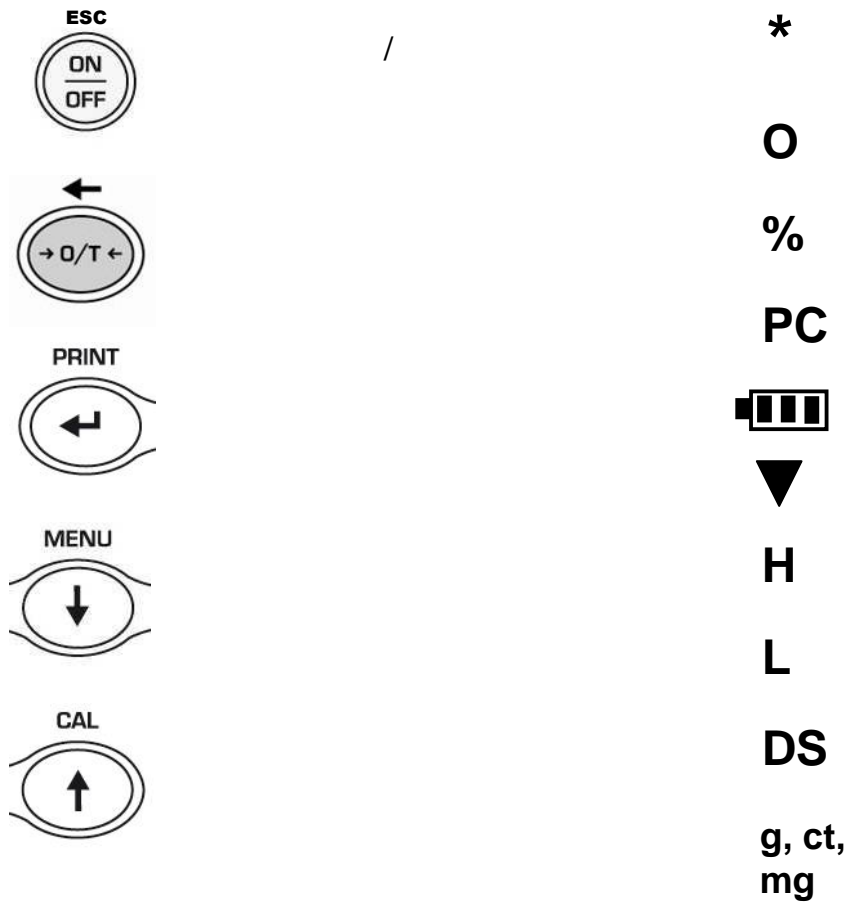
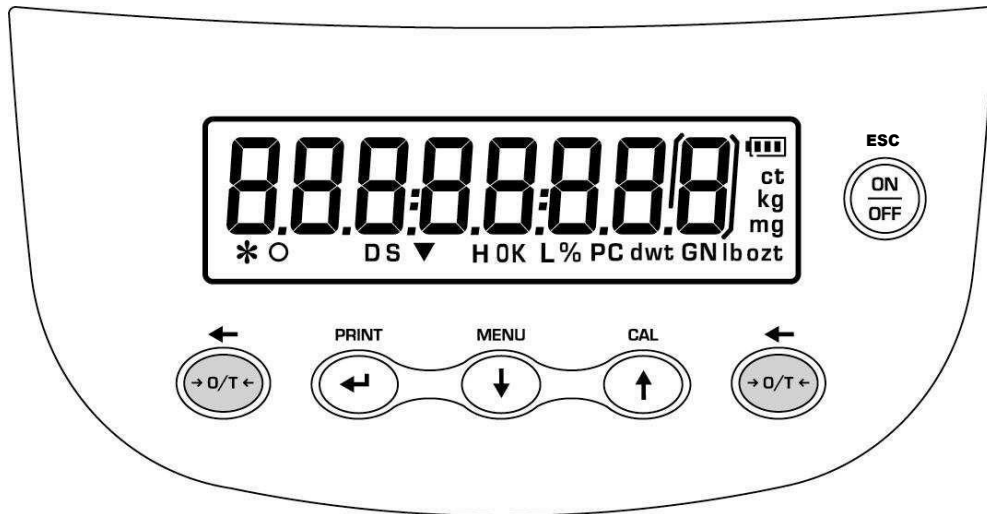

5

5.1

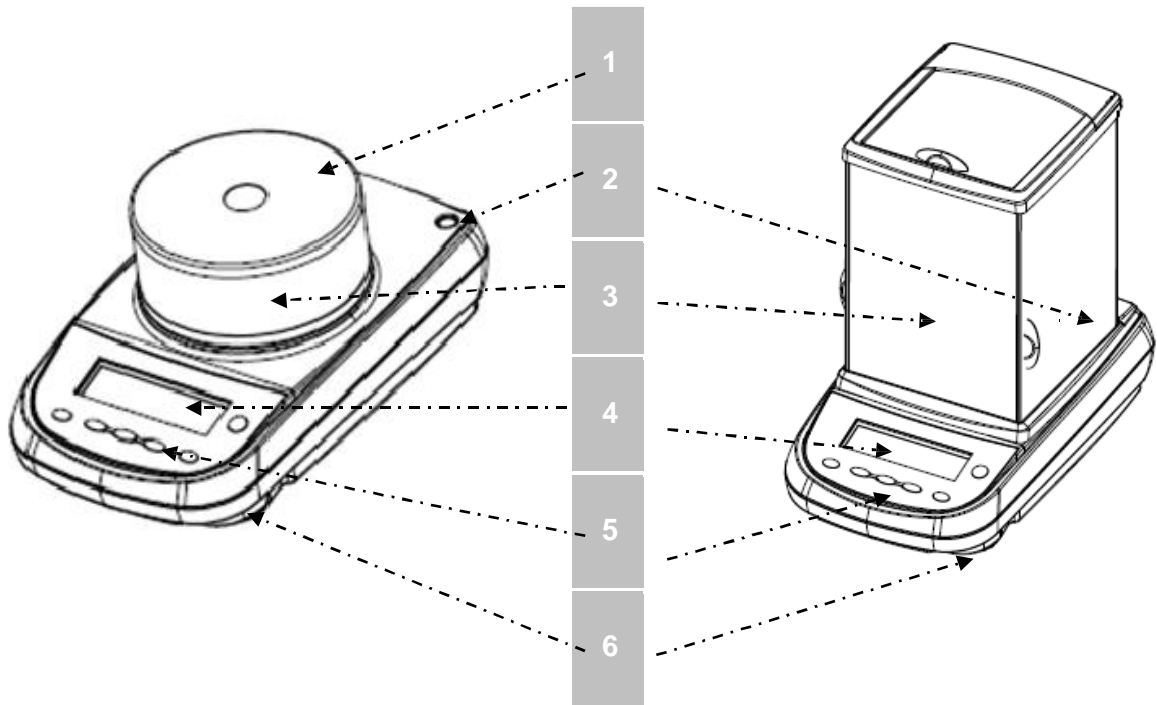

.1

1	
2	
3	
4	
5	
6	

5.2

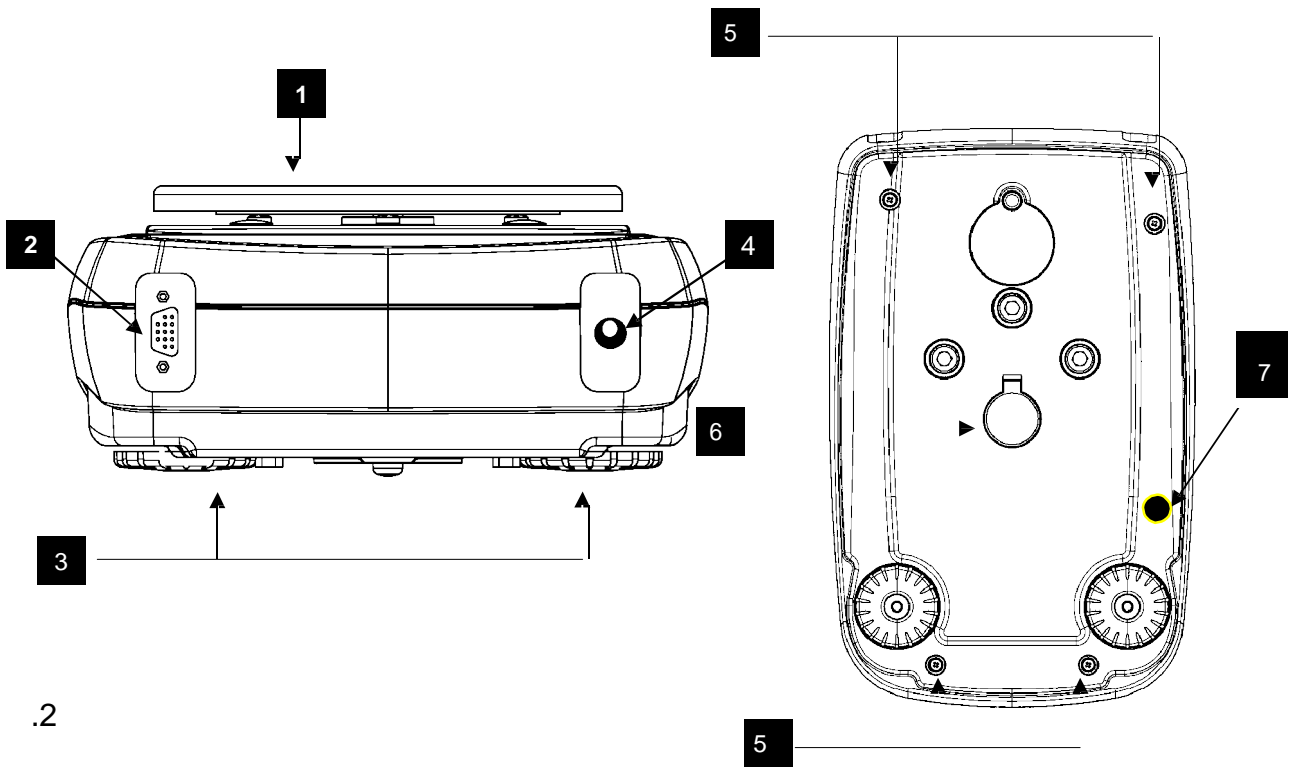

(.2)	
1	
2	RS232
3	
4	
5	4
6	(d=0.001 d=0.01).
7	(_____ Max 4200 _____).

6



Í WARM UPÍ,



6.1

• ON/OFF
• ON/OFF



6.2

« » (*).



7

7.1



CAL.

1. CAL.



2.

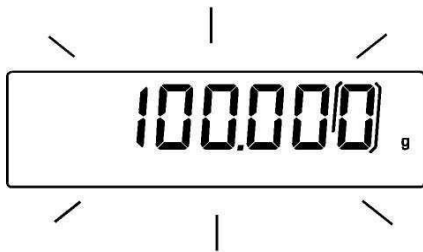

3.

4.

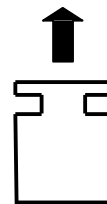

1. CAL,
"LOAD".

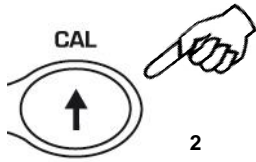

"-CAL-"

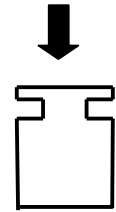
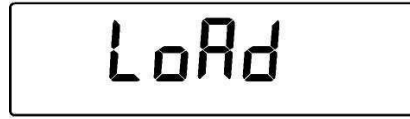

- 2.

300

%LOAD+

200 .,
100 , 200 ,
(, 150 . .).

- 3.

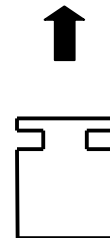

7.2

* (« »)
4 :

MENU.
MENU Í Calibî . %unitS+, PRINT.

1. MENU:

- AUT-CAL:
- I-CAL:
- E-CAL:
- TEC-CAL:

*

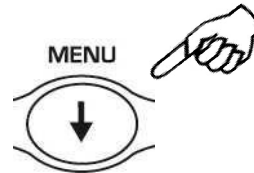

2. %AUT-CALÎ , %CALÎ %E-CALÎ PRINT.
%TEC-CALÎ PRINT

3. MENU

7.2.1 (AUT-CAL)



CAL 25

ON/OFF

5 ;

:

!

CAL,

1.

CAL.

%CAL

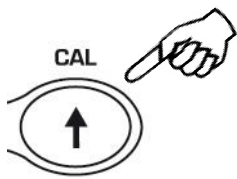

2.



%CAL bUt

CAL.

7.2.2

(I-CAL)

CAL.

7.2.3

(E-CAL)

(

§7.1)

).

(

7.2.4

(TEC-CAL)

1.

TEC-CAL

CAL.
Í CALÍ.

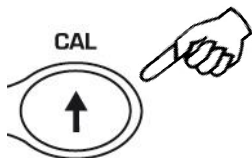

2.

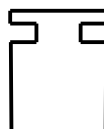
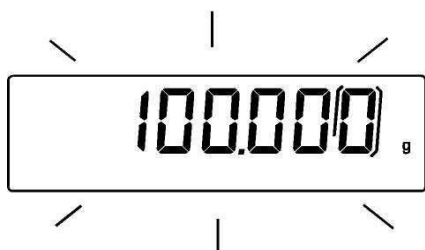

3.

4.

%0.000±

PRINT

%TEC-MEM±

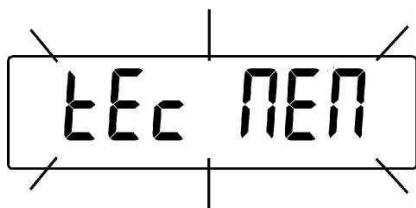

5.

6.

(§7.2)

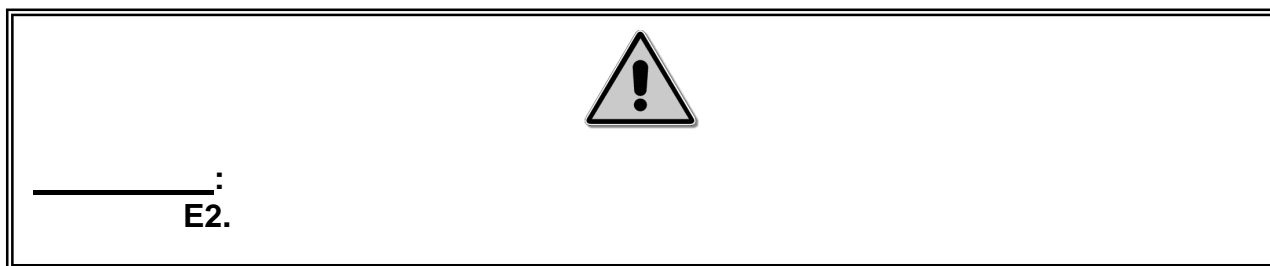

7.3

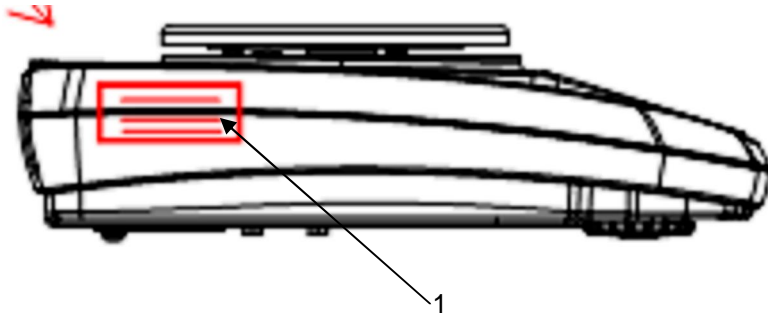

(1 .)

8

1.

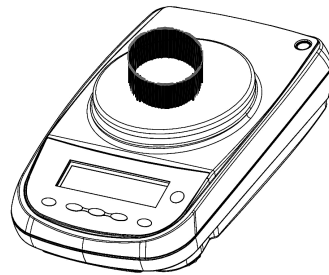

2.

0/T.

%-t±

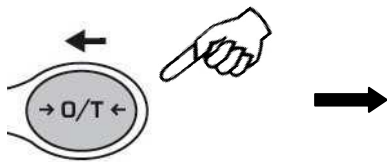

3.

: %0.000±



4.

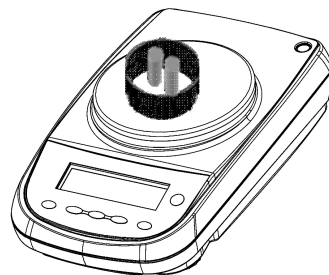

8.1

1. O/T,

2.

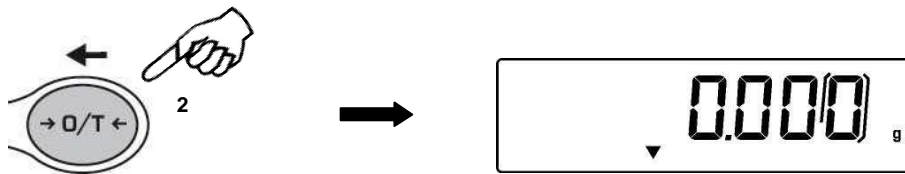

3. CAL MENU.
O/T.



4. PRINT

TARE/DELETE.

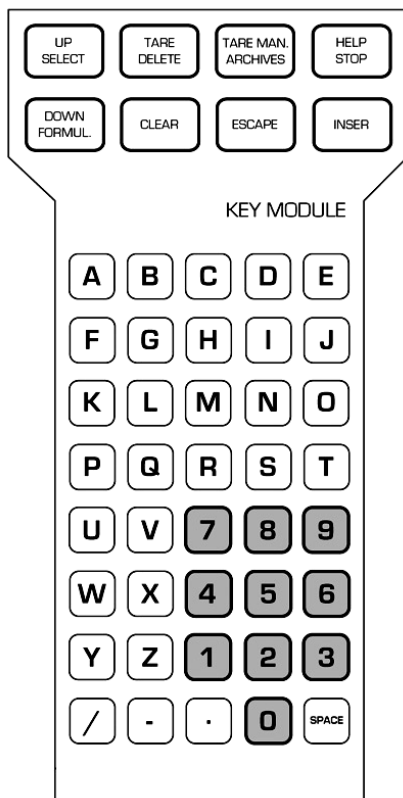

1. TARE MAN

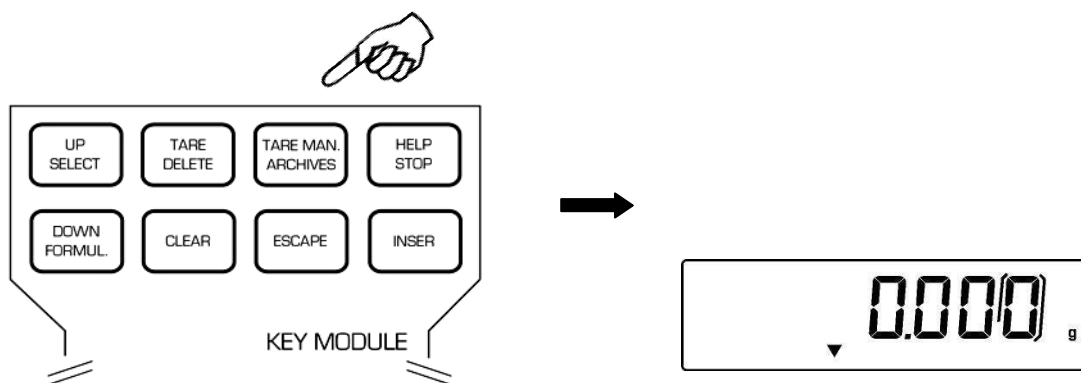

2. **CLEAR**

,

.



3. **INSER** confirm.

4. **ESCAPE**

.

.

9

(unit 1)
unit 1.

(unit 2).

1.

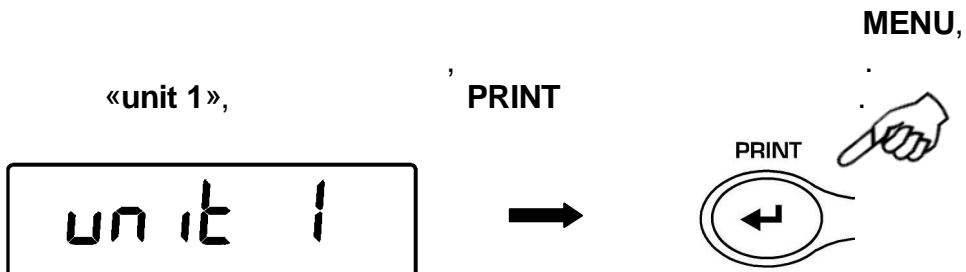

2.

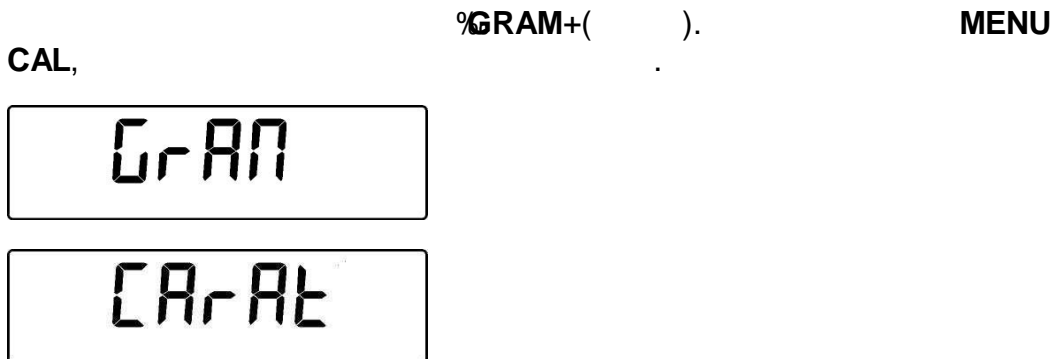

3.

PRINT

		1g =
GRAM		1
MiLLiGr		0.001
CARAT		5
OUNCE	**	0.035273962
POUND	**	0.0022046226
PENN.	**	0.643014931
ONCETR.	**	0.032150747
GRANO	**	15.43235835
Tael HON	()**	0.02671725
* Tael SGP	()**	0.02646063
* Tael ROC	()**	0.02666666
* MOMME	**	0.2667
M 10	x 10**	10
M 100	x 100**	100

**

4. MENU unit1 (PRINT)

5. "unit 2" , PRINT

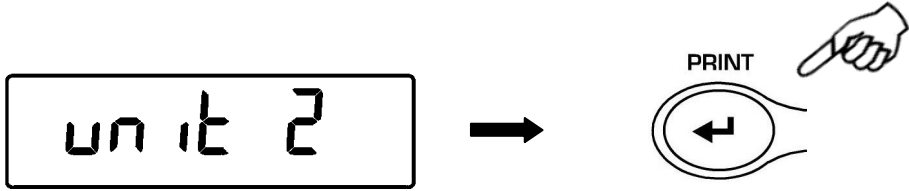

6. CAL, «GrAM» (). MENU
MENU, PRINT
(3).

7. MENU , ,

8. PRINT, ,

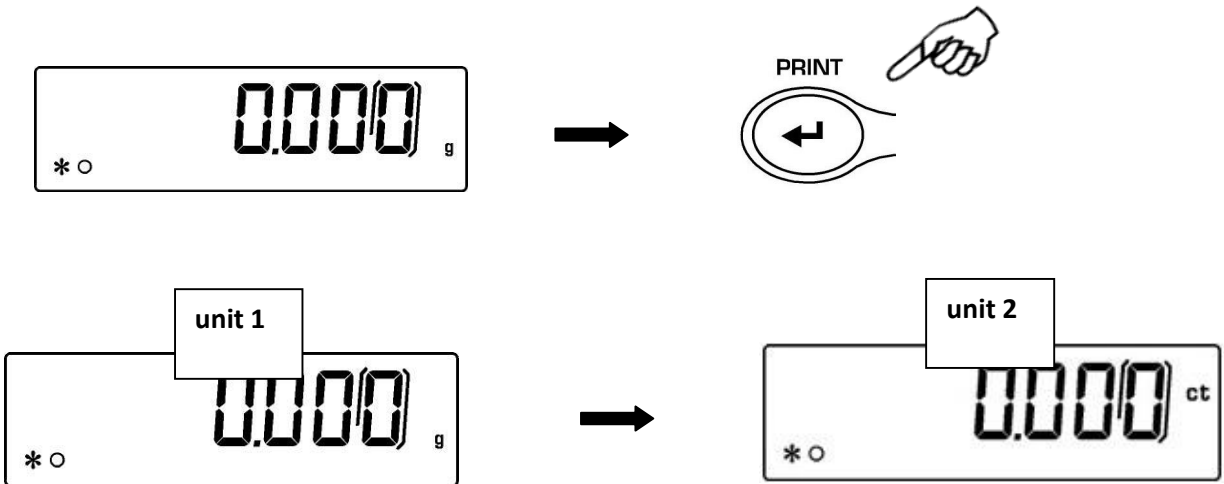

(§25)

- 1. MENU MENU %unitS+ , PRINT.
- 2. MENU %RC-PRTR+ PRINT.

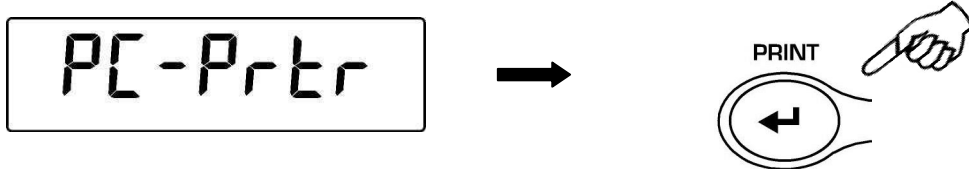

- 2. MENU %RC CMD/ PRINT
- 3. MENU %RC cont+ PRINT

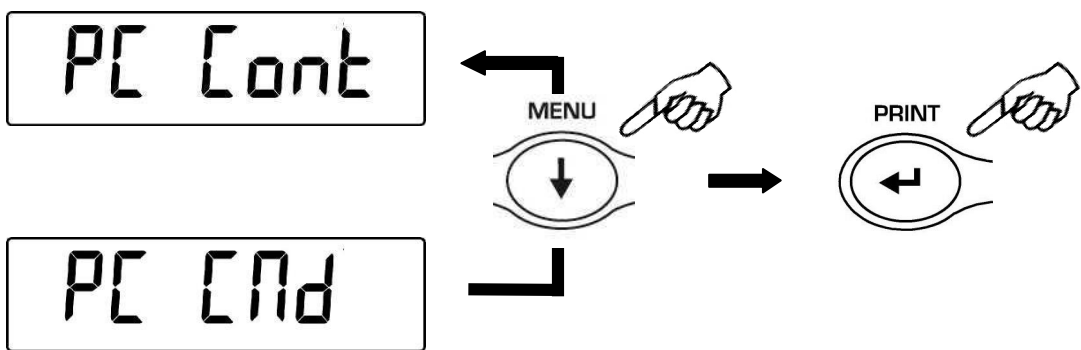

- 3. CAL MENU
- 4. MENU, MENU,
- 5. MENU,



: (§12)

(§25)

1.

MENU

MENU

PC-PRTR

UNIT

PRINT

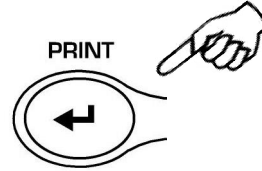
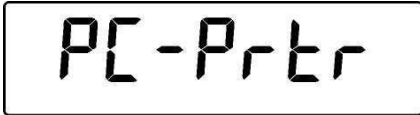

2.

PRINT TLP50

MENU

TLP50

3.

PRINT

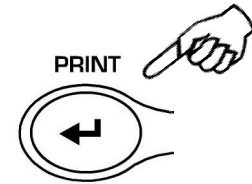
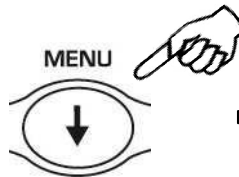

4.

CAL

MENU

5.

MENU

PRINT



:

(§12)

12

1.

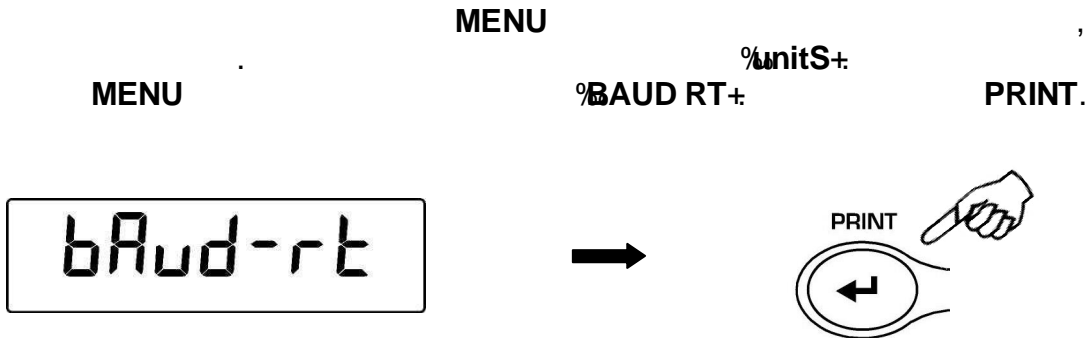

2.

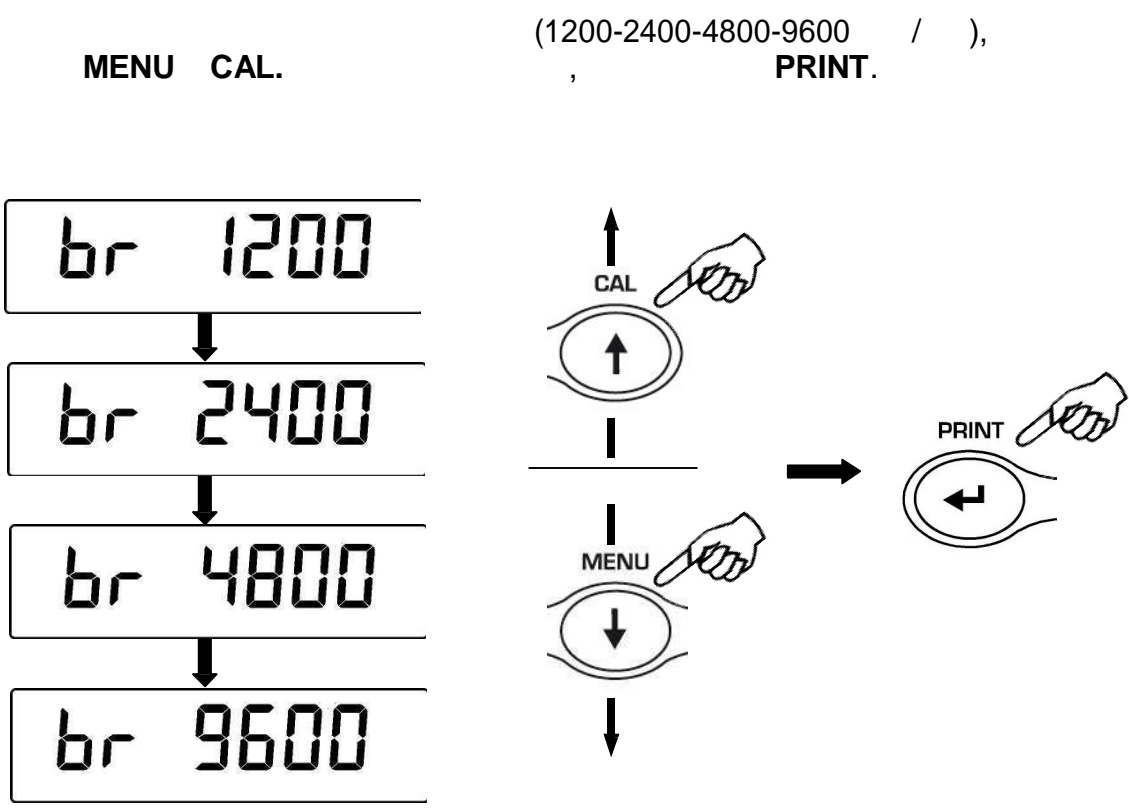

3.

CAL MENU

4.

MENU,

5.



- Au0 OFF -
- Au0 1
- Au0 2*
- Au0 3*
- Au0 3E*



*

1.

MENU

MENU

%AUTO 0+

%unitS+

PRINT.

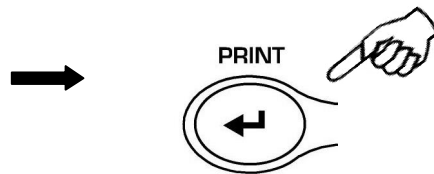

2.

MENU

CAL,

PRINT.

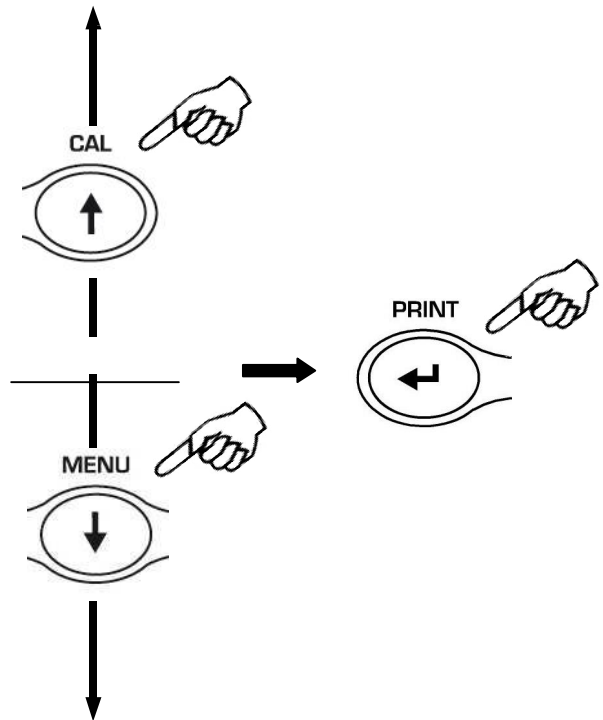
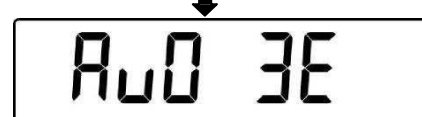
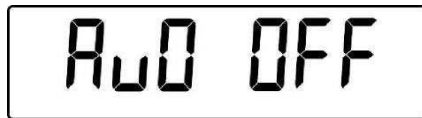

3.

CAL

MENU

4.

MENU,

FILTER 1:
 FILTER 2:
 FILTER 3:

1. MENU MENU %unitS+ %FILTER+ PRINT.

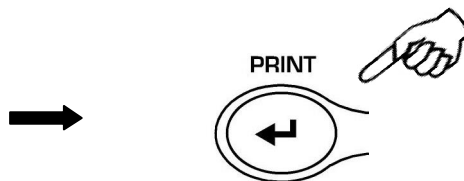
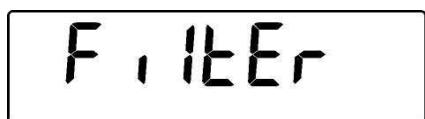

2. MENU CAL, PRINT.

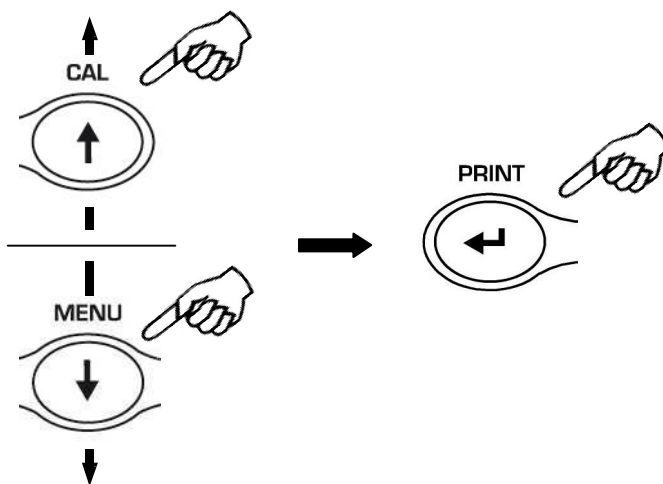
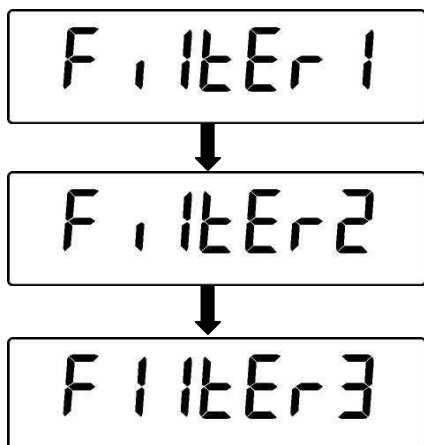

3. CAL MENU

4. MENU,



: FILTER 1

- STAB 1 =
- STAB 2 =
- STAB 3 =

1. MENU MENU %unitS+ PRINT.
2. MENU CAL, PRINT.

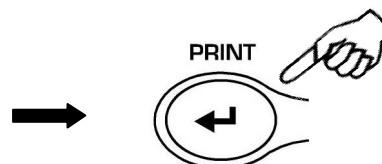
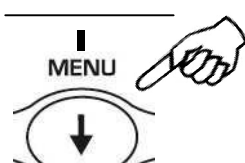
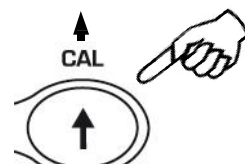
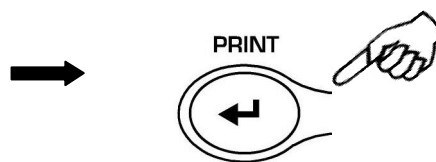
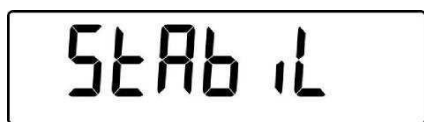

3. CAL MENU

4. MENU,

- 5.



15

1.

MENU

MENU

Contr +

unitS+

PRINT.

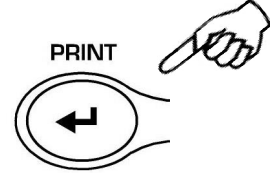

2.

MENU CAL,

PRINT.

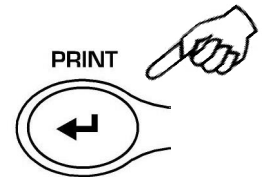
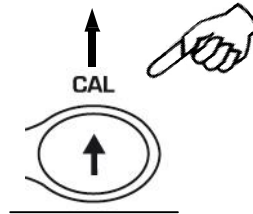
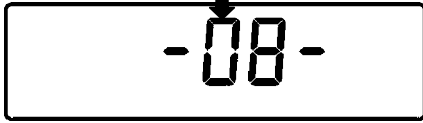
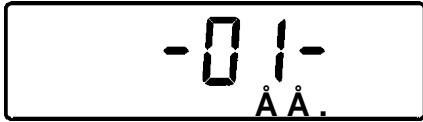

3.

CAL

MENU

4.

MENU,

5.



3

•
•
•

1.

MENU

unitS+

MENU

bLt +,

PRINT.

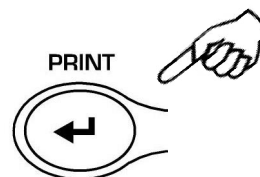
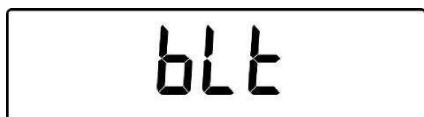

2.

MENU

CAL,

PRINT

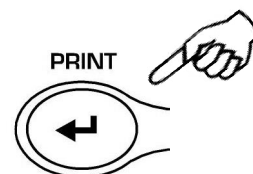
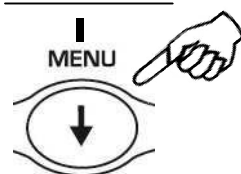
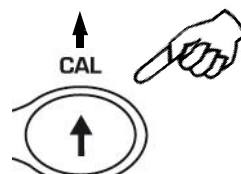

3.

CAL

MENU

4.

MENU,

5.



4

- disab =
- 2 Min =
- 5 Min =
- 15 Min =

- 2
- 5
- 15

1.

MENU

MENU

ME OFF

PRINT.

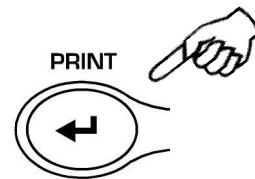
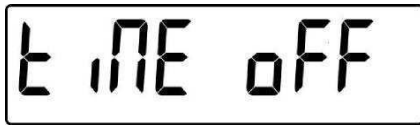

2.

MENU CAL,

PRINT.

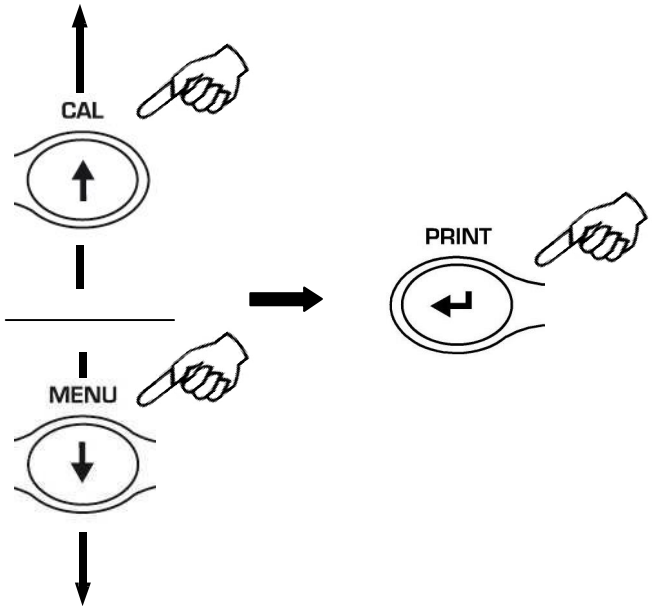
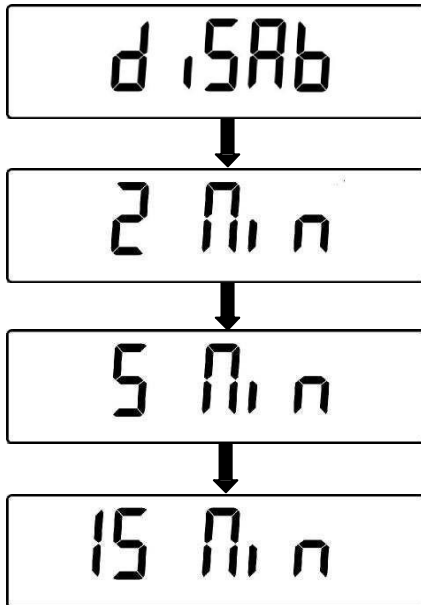

3.

CAL

MENU

4.

MENU,

5.



1.

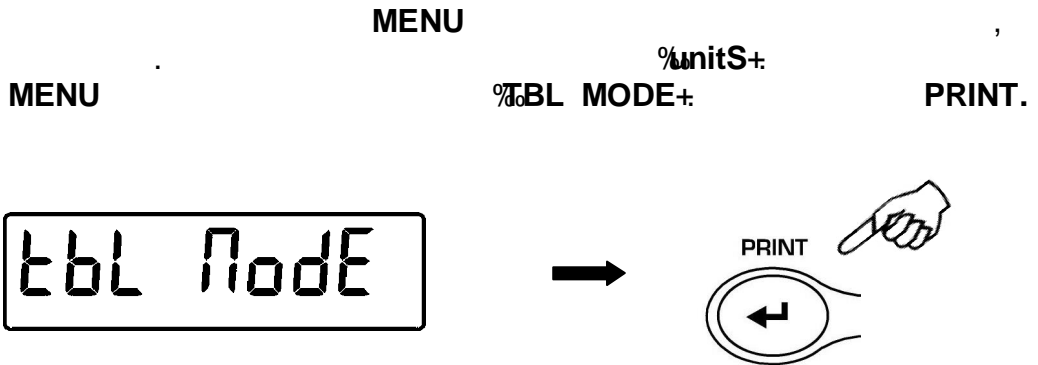

2.

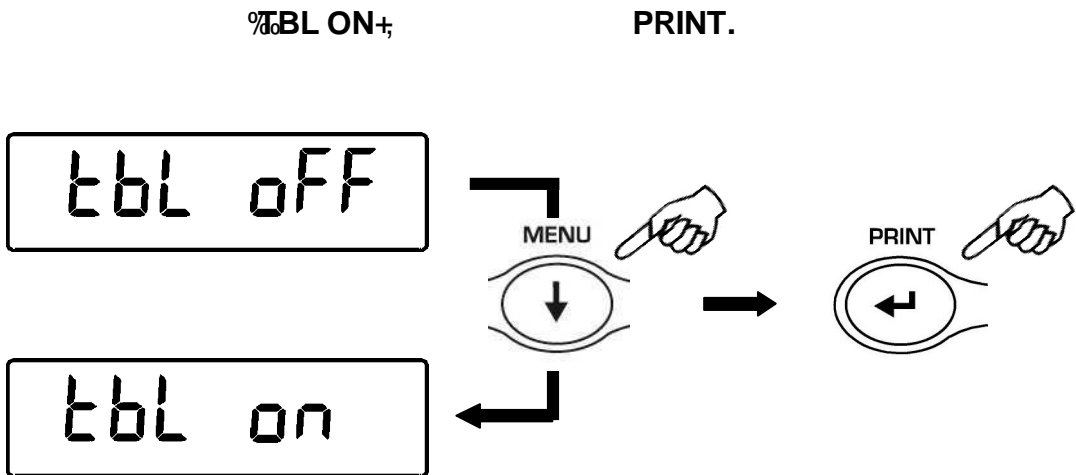

3.

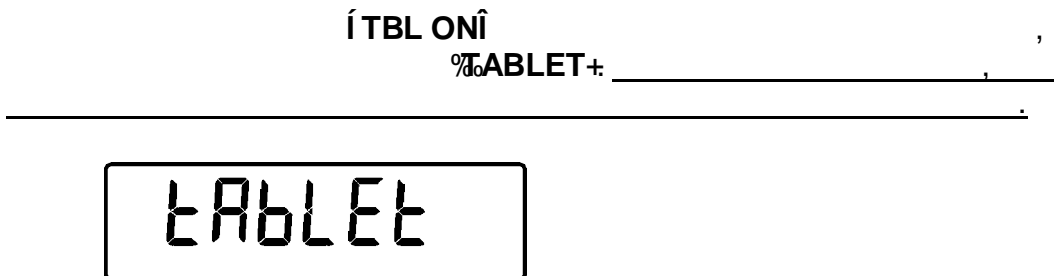

4.

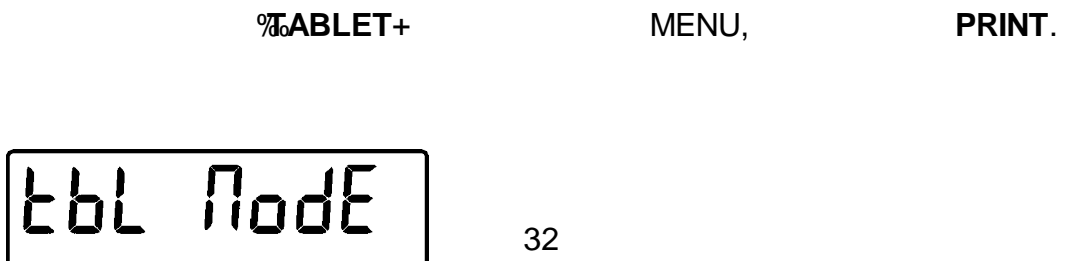

5.

PRINT MENU

%TBL OFF+;

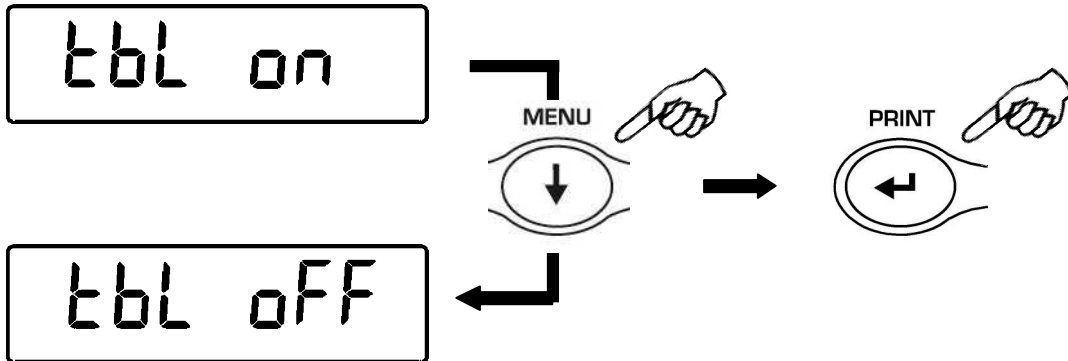

6.

PRINT

20

1. MENU
PRINT

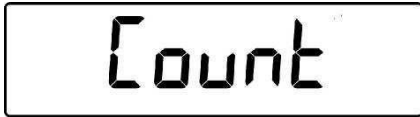

Í Count Í,

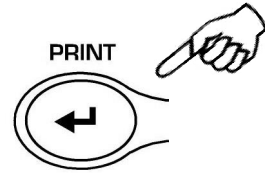

2. MENU

CAL
(10, 25, 50, 100)

PRINT.



PRINT

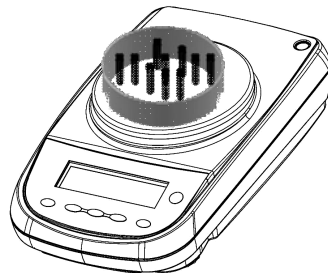
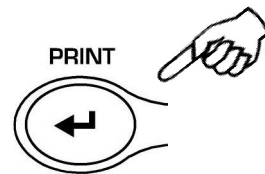

(, 10)



Í AddÍ.

PRINT.

Í Add SMPÍ .

Add SNP

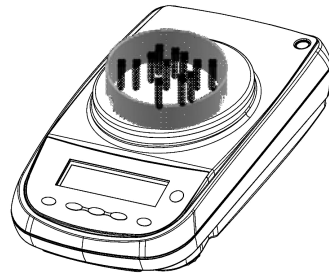

* 30 PC

3.

ON/OFF,

20.1

1.

MENU

* 30 PC
↓
* 170.30(8)

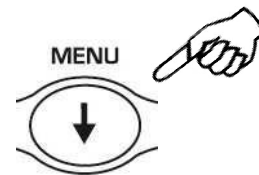

2.

MENU

3.

MENU.

20.2

1.

PRINT. MENU MANUAL,

í Countî, MENU.

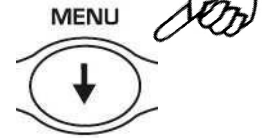
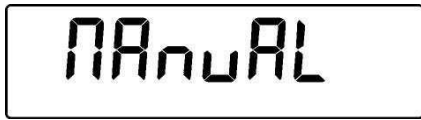

2.

PRINT

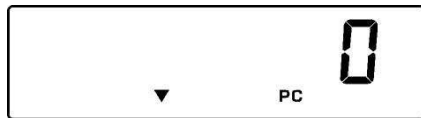

3.

CAL MENU

O/T. CA. O/T.

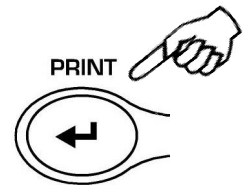
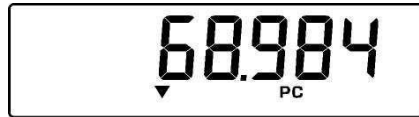
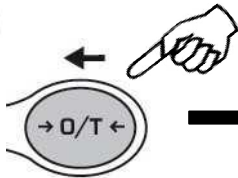
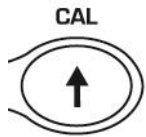

4.

PRINT

100

ON/OFF.

5.

%

6.

MENU

7.

ON/OFF.

():

1.

MENU
PRINT
MANUAL,

í Countî ,
MENU.

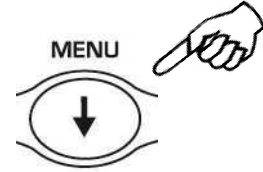

2.

PRINT.

3.

9

CLEAR.

0

4.

INSERT

5.

100

ESCAPE

ON/OFF

6.

0;

7.

MENU

8.

ON/OFF.

20.3

:

1.

2.

255

:

().

21.1

1. Í dEnSî, PRINT MENU

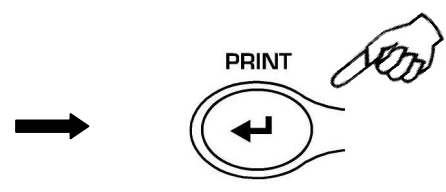
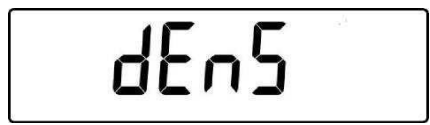

2. Í d SoLidî, PRINT. MENU,

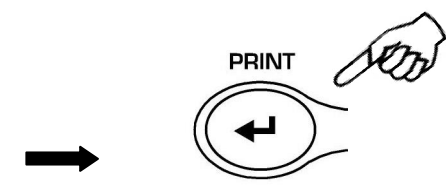

3. 1.0000 (20°C).

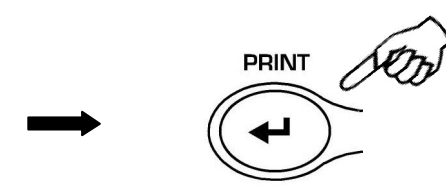

4. CAL MENU. O/T, O/T



5.

().

6.

PRINT.

7.

PRINT

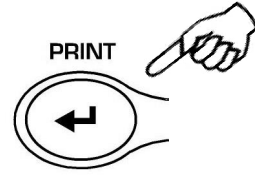

8.

PRINT

WEI AIR

9.

WEI LIq.

PRINT.

PRINT.

WEI LIq

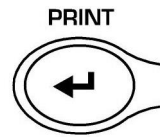
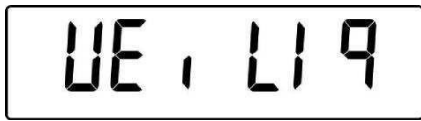

10.



11.

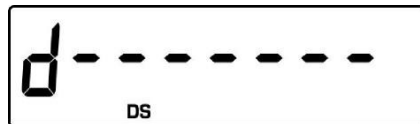

12.

MENU ON/OFF

21.2

1. Í dEnSÍ, PRINT MENU

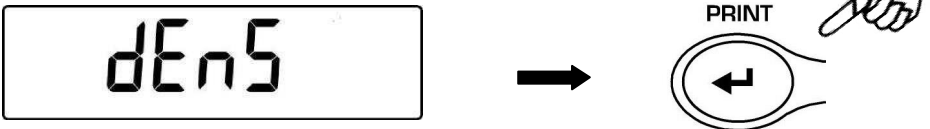

2. MENU, PRINT. Í d LiquidÍ,

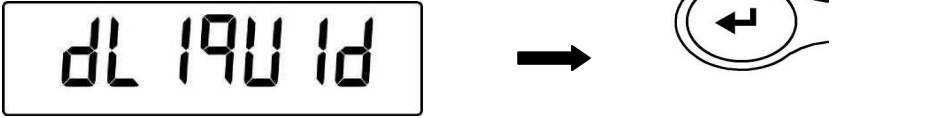

3. 3.0000.



4. CAL MENU. O/T, O/T



5. ().

6. PRINT.

7.



PRINT.

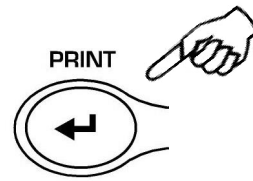

8.

PRINT.

WEI AIR

9.

PRINT.

WEI LIq.

PRINT.

WEI LIq

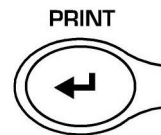

10.



11.

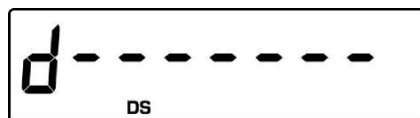

12.

MENU ON/OFF

M LOAD

- 1. Í M Loadí , M LOAD

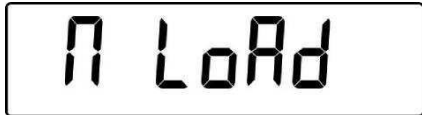

MENU
PRINT

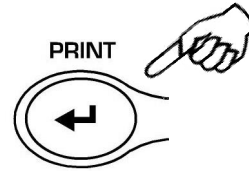

- 2.



M.

- 3.



- 4. TARE

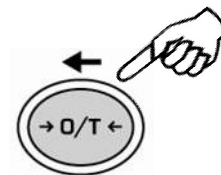

- 5. M LOAD

- 6. ON/OFF

M LOAD.

() (: 100%.

23.1

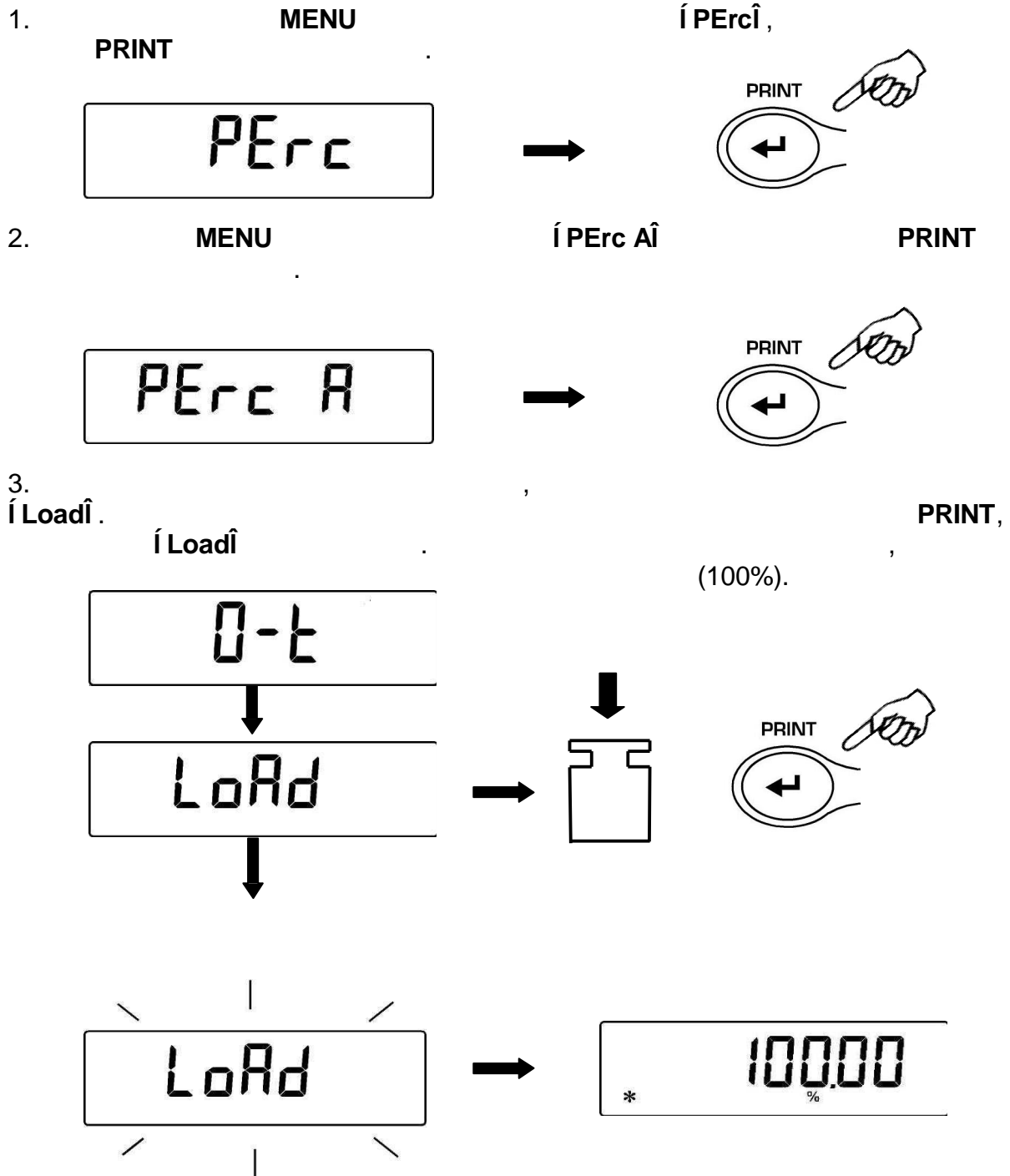

4. %

5. MENU %.

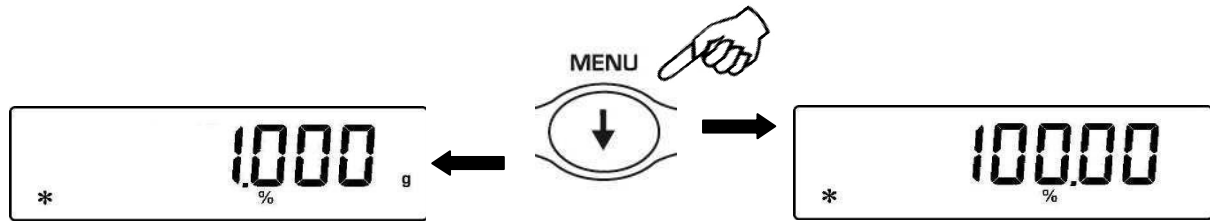

6. ON/OFF

ERROR 07.

23.2

1. PRINT MENU

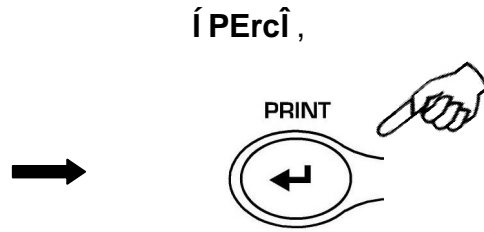

2. MENU

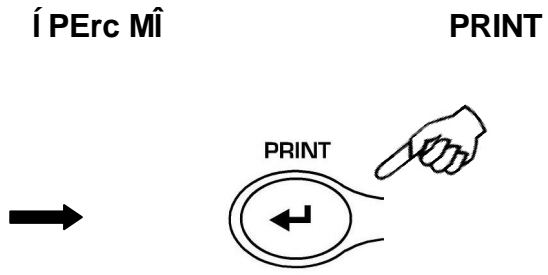

3.

O/T. CAL MENU. O/T,



4. PRINT

5.

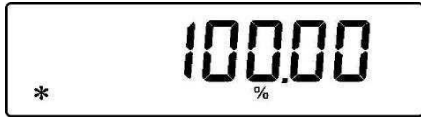

6. MENU

%.
%

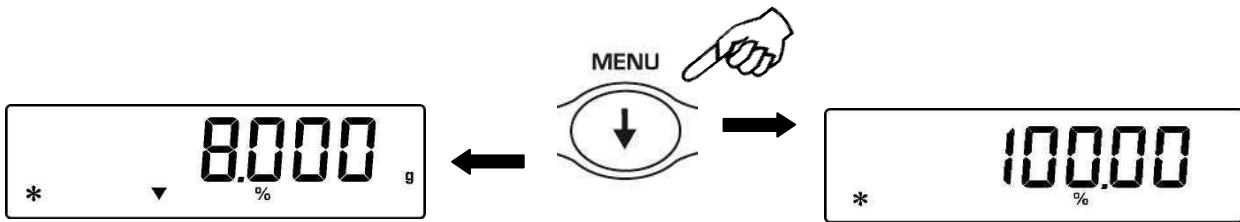

7. ON/OFF

8.

().

ERROR 07.

1. MENU
PRINT

Í AniM UEiî ,

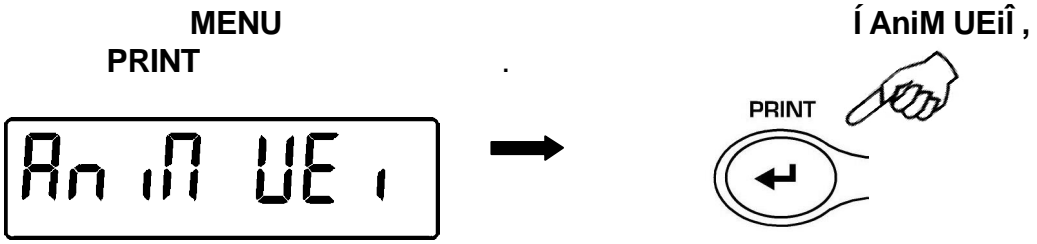

2. 5 90 ,
PRINT.

MENU CAL.

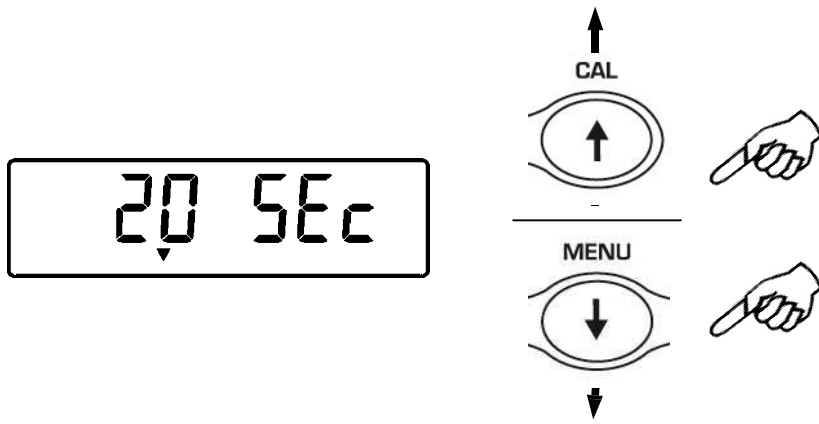

3. () ,
PRINT

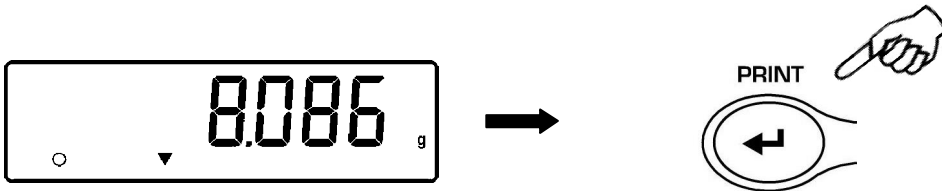

4.

5.



6. ON/OFF

1.

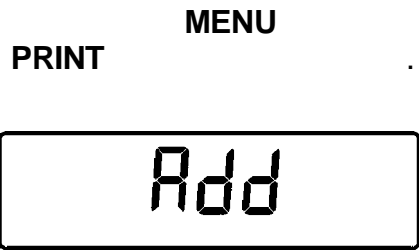

Í Addi ,

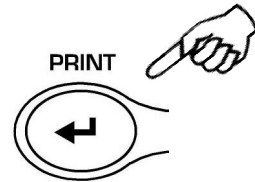

2.

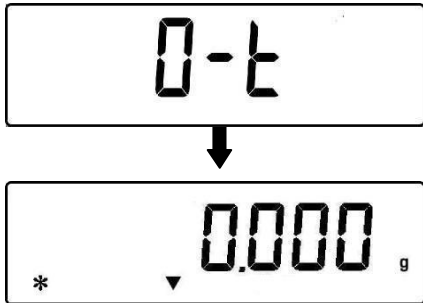

3.

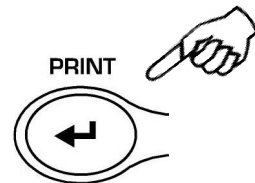

4.

PRINT.

5.

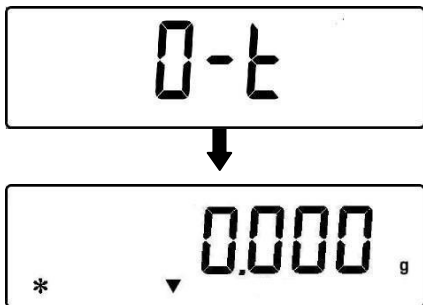

6.

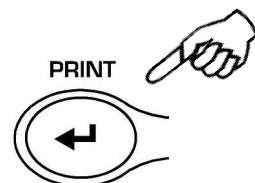
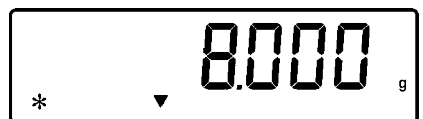

7.

PRINT.

99.

8.

MENU,

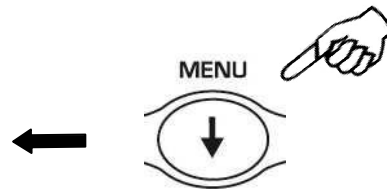

PRINT

CAL

9.

ON/OFF

1.

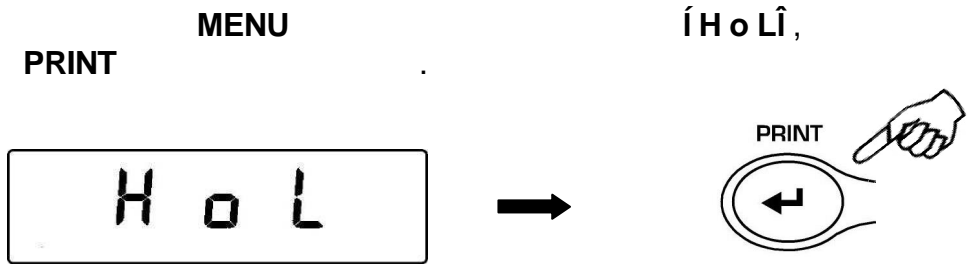

2.

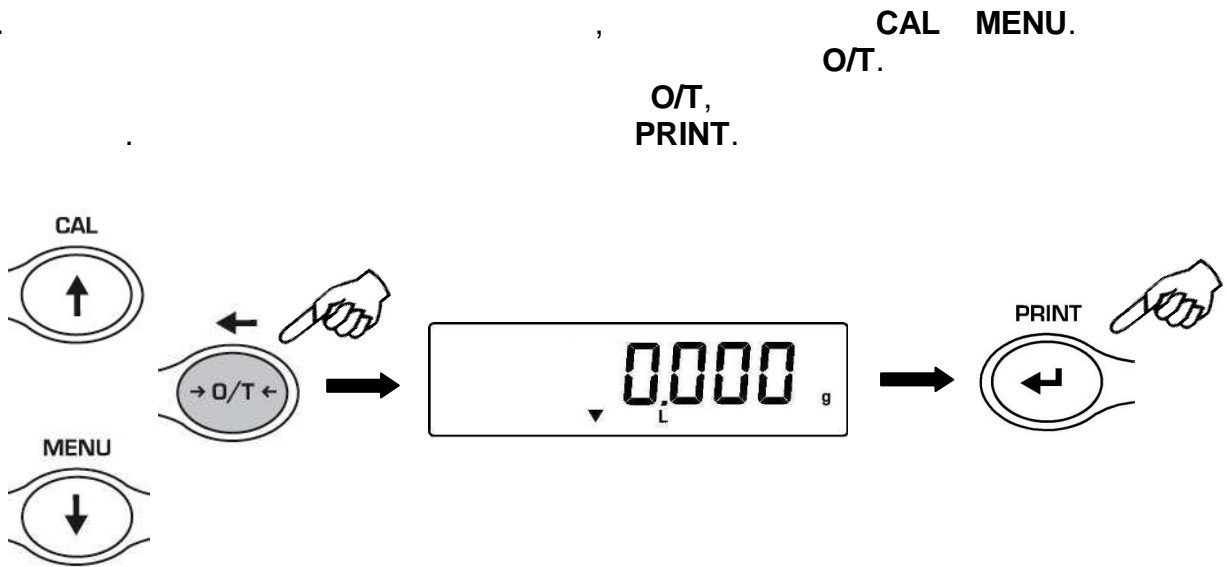

3.

4.

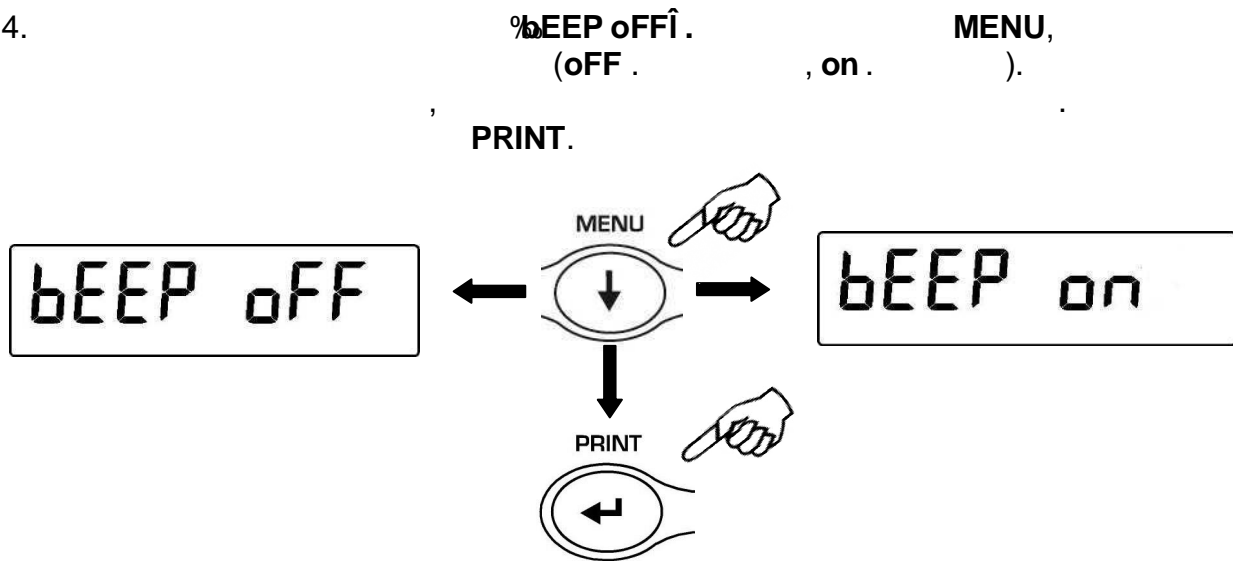

5.

= , OK= (H = , L

:

ERROR 07.

26.1

) (H. L;

26.2

L.

26.3

H.

1.

RS232C,

PRINT(. §10).

RS232C,

(. §12) 1200, 2400, 4800 9600

8

2.

(IBM-)
Í PC Contî,

Í PC CMdî

PRINT.

ASCII,

	1 ()
%t+ = H54	
%c+ = H43	
%e+ = H45	
%M+ = H4D	
%D+ = H4F	/

	2 ()
%t+ = H74	
%c+ = H63	
%e+ = H65	
%M+ = H6D	
%D+ = H6F	/

3.

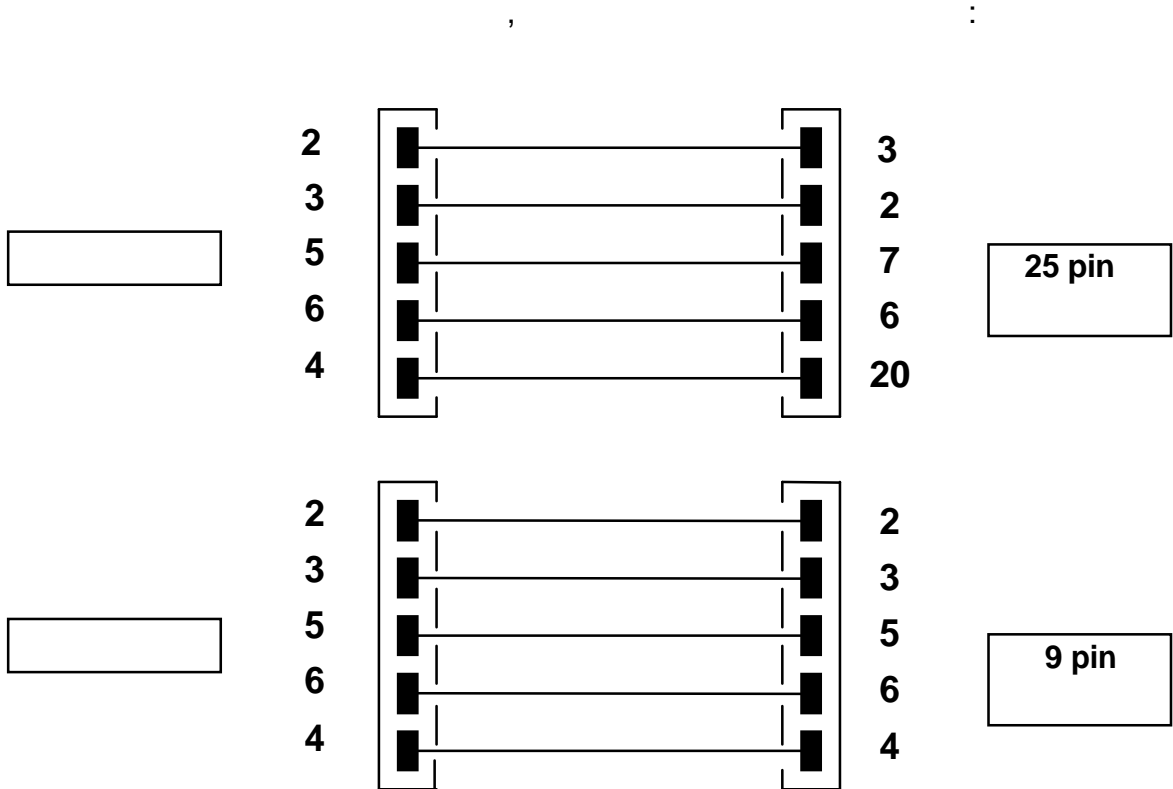

4.

- 1 : (14)
- 2~9 :
- 10~12 :
- 13 :
- 14 :
- 15 :

1°	2°	3°	4°	5°	6°	7°	8°	9°	10°	11°	12°	13°	14°	15°
												.	CR	LF

1°	2°	3°	4°	5°	6°	7°	8°	9°	10°	11°	12°	13°	14°	15°	16°	17°
d	=														CR	LF

()

1°	2°	3°	4°	5°	6°	7°	8°	9°	10°	11°	12°	13°	14°	15°	16°	
Pcs			:													

1°	2°	3°	4°	5°	6°	7°	8°	9°	10°	11°	12°	13°	14°	15°	16°	17°	18°	19°	20°
Weight						:											g	S	

:

1°	2°	3°	4°	5°	6°	7°	8°	9°	10°	11°	12°	13°	14°	15°	16°	17°	18°
PMU			:														g

()

1°	2°	3°	4°	5°	6°	7°	8°	9°	10°	11°	12°	13°	14°	15°	16°	17°	18°	
Perc				.														%

1°	2°	3°	4°	5°	6°	7°	8°	9°	10°	11°	12°	13°	14°	15°	16°	17°	18°
Weight																g	

()

1°	2°	3°	4°	5°	6°	7°	8°	9°	10°	11°	12°	13°	14°	15°	16°	17°	18°
----	----	----	----	----	----	----	----	----	-----	-----	-----	-----	-----	-----	-----	-----	-----

Time		=			Sec	
------	--	---	--	--	-----	--

1°	2°	3°	4°	5°	6°	7°	8°	9°	10°	11°	12°	13°	14°	15°	16°	17°	18°
Ave		.	=											g			

()

1°	2°	3°	4°	5°	6°	7°	8°	9°	10°	11°	12°	13°	14°	15°	16°	17°	18°
		.											g				

1°	2°	3°	4°	5°	6°	7°	8°	9°	10°	11°	12°	13°	14°	15°	16°	17°	18°
S		=											g				

()

1°	2°	3°	4°	5°	6°	7°	8°	9°	10°	11°	12°	13°	14°	15°	16°	17°	18°	19°	20°
Weight						:	.									g			

Ok

1°	2°	3°	4°	5°
- Low -				

1°	2°	3°	4°	5°
- High -				

1°	2°	3°	4°	5°
- Ok -				

5.

Í Printí

PRINT

10

ERR05

6.

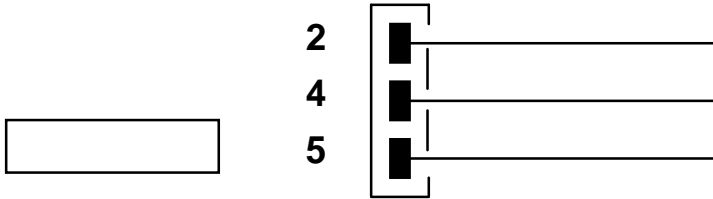

TLP50,

12-02-2008	12:00
Weight:	22.000 g

12-02-2008	12:00
Pcs	100
Weight:	300.000 g
PMU:	3.000 g

12-02-2008	12:00
d=	2.80066 g/cm ³ d

12-02-2009	12:00
Perc.	100.0%
Weight:	300.000 g

12-02-2009	12:00
Time =	6 Sec
Ave. =	59.446 g

12-02-2010	12:00
1.	16.589 g
2.	17.226 g
ō	
99.	

S=	33.815 g

12-02-2013 12:00
Weight: 0.00g
-LOW-

12-02-2012 12:00
Weight: 49.20g
- OK -

12-02-2011 12:00
Weight : 249.42g
-HIGH-

7.

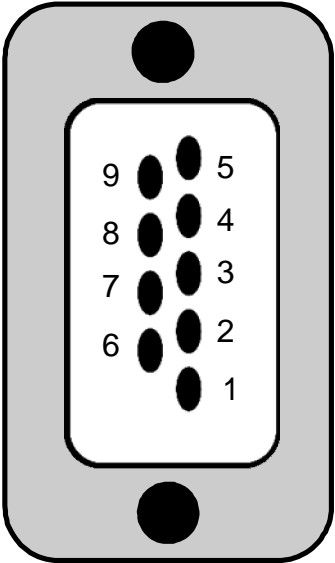

8.

RS232



1:

- pin 1 = +5V
- pin 2 =
- pin 3 =
- pin 4 =
- pin 5 =
- pin 4-6 =

ERR01		
ERR02	-	
ERR03		.
ERR04		.
ERR05		
ERR06		
ERR07		
ERR08		
%UNLOAD+		.
%CAL But±		CAL
		
		

29

1)

2)

-
-
-

-
-
-

PRINT

MENU

MENU
CAL

MENU

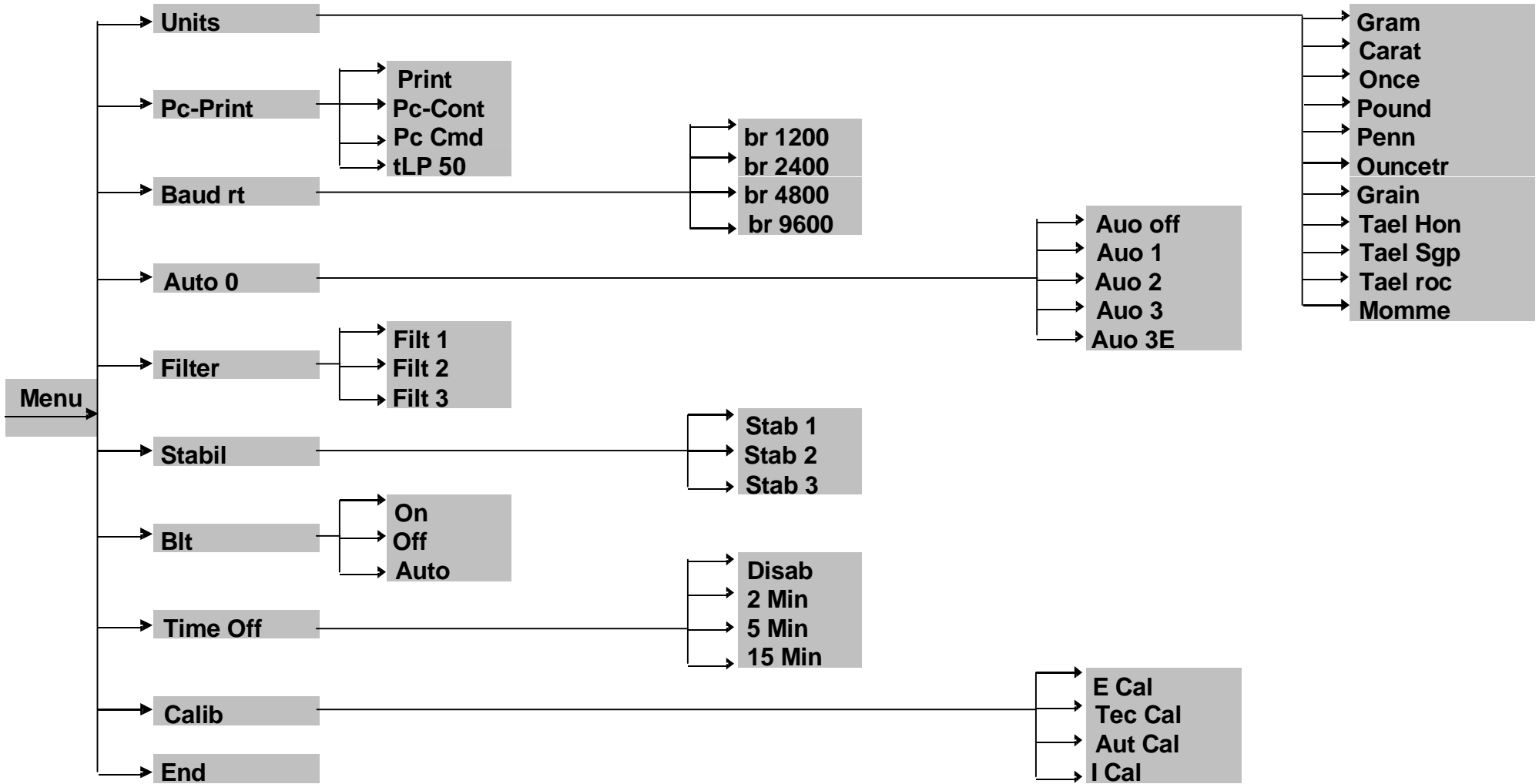

•
•
•
PRINT

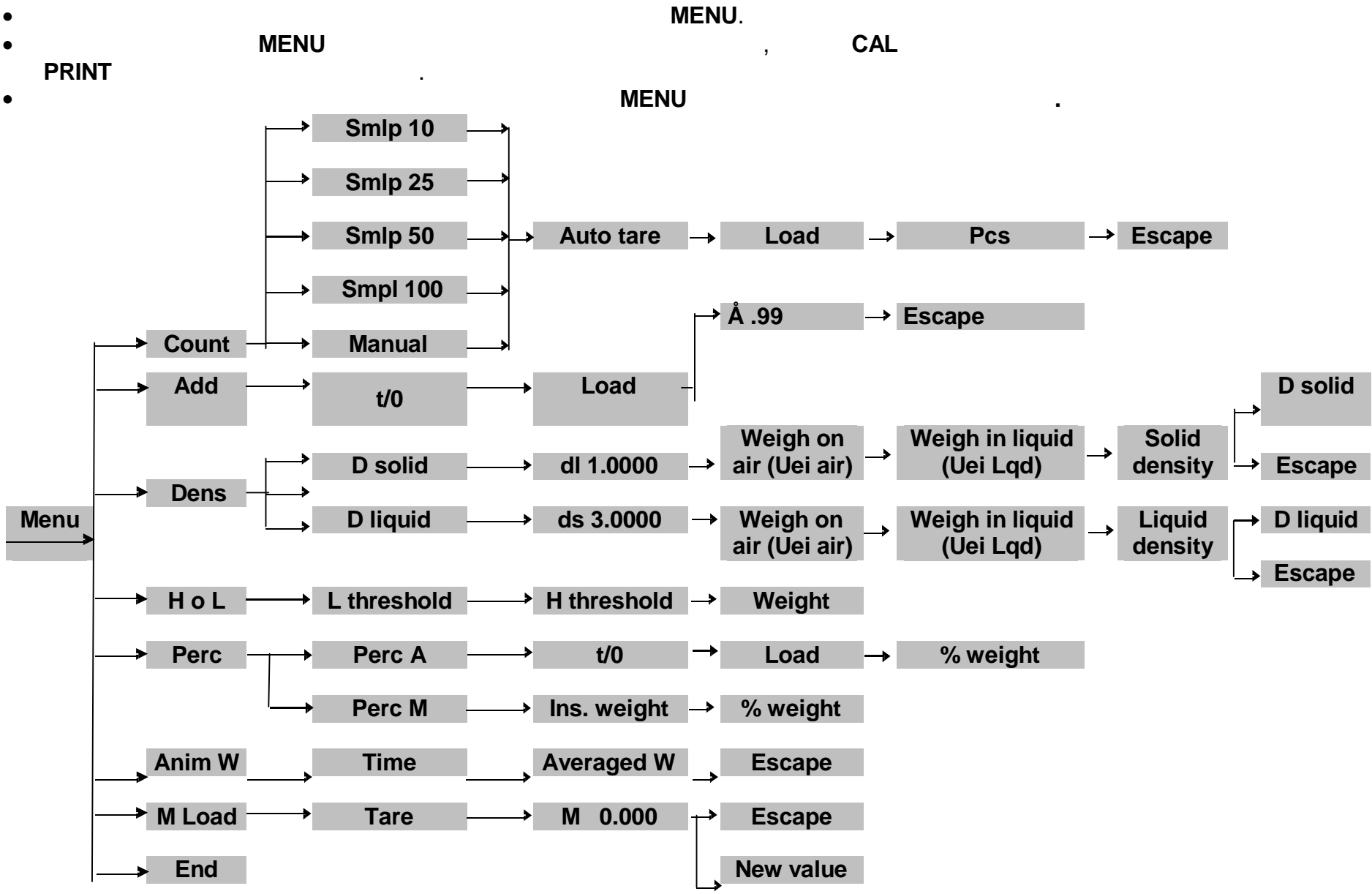

	DA-65C	DA-125DC	DA-124[C]	DA-225DC	DA-224[C]
OIML R 76-1. 2011	I				
(),	62	120	120	220	220
(),	0,001	0,001	0,001	0,001	0,001
(d),	0,00001	42 ∴ 0,00001; .42 ∴ 0,0001	0,0001	82 ∴ 0,00001; .82 ∴ 0,0001	0,0001
(n)	62000	120000	120000	220000	220000
	100 %				

	DA-314C	DA-514C	DA-1003C	DA-1203C	DA-2103C
OIML R 76-1. 2011	I				
(),	310	510	1000	1200	2100
(),	0,001	0,001	0,01	0,01	0,01
(d),	0,0001	0,0001	0,001	0,001	0,001
(n)	310000	510000	100000	120000	210000
	100 %				

	DA-8202	DA-223C	DA-333C	DA-523C	DA-723C
OIML R 76-1. 2011	I	II			
(),	8200	220	330	520	720
(),	0,1	0,01	0,01	0,01	0,01
(d),	0,01	0,001	0,001	0,001	0,001
(n)	82000	22000	33000	52000	72000
	100 %				

	DA-2202C	DA-3102C	DA-4202C	DA-5202C	DA-6202C
OIML R 76-1. 2011	II				
(),	2200	3100	4200	5200	6200
(),	0,1	0,1	0,1	0,1	0,1
(d),	0,01	0,01	0,01	0,01	0,01
(n)	22000	31000	42000	52000	62000
	100 %				

100% Max

:

24

:

220^{+10%} ;
-15%

50±1.

OIML R76-1-2011

36

48

-

-

-